

DETAIL A
SCALE 1 / 8

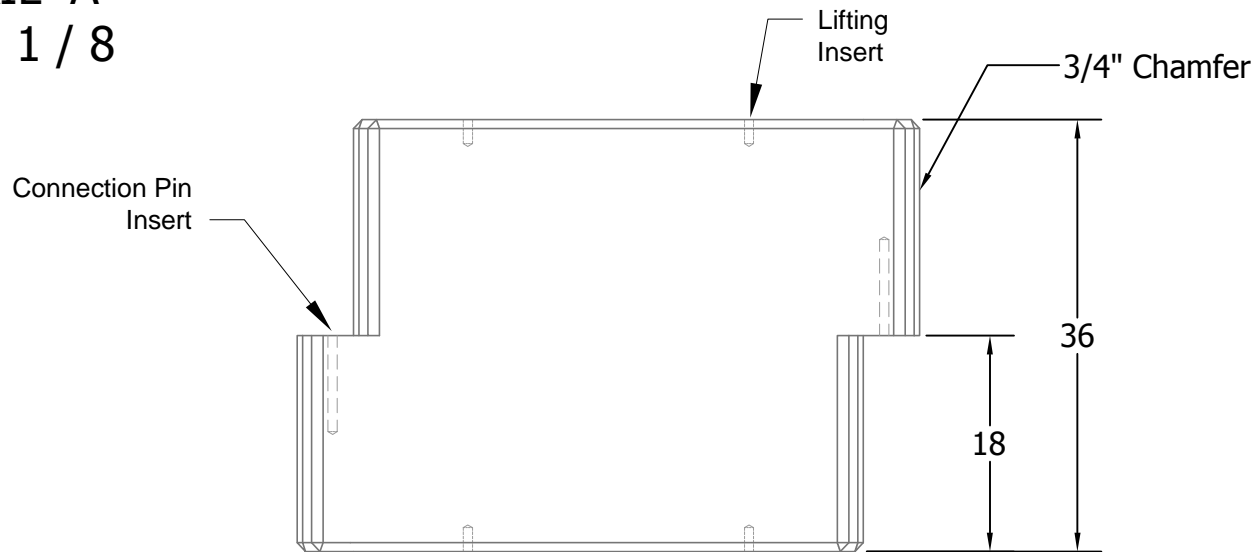

No.	Date	Revision	By

The information on this drawing is for conceptual design and should not be used without the signature of a professional engineer. Details should be specific to the project and project site requirements.

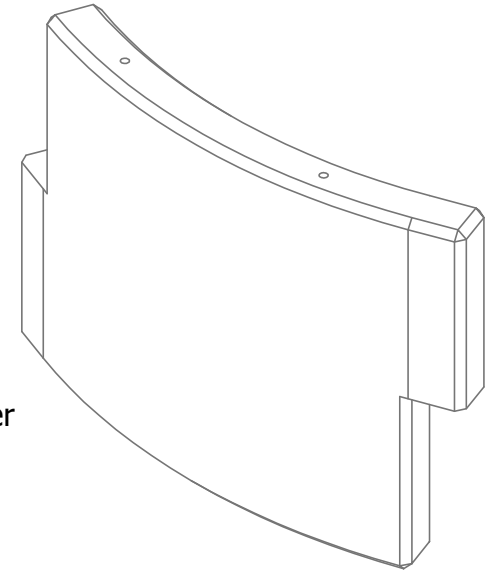
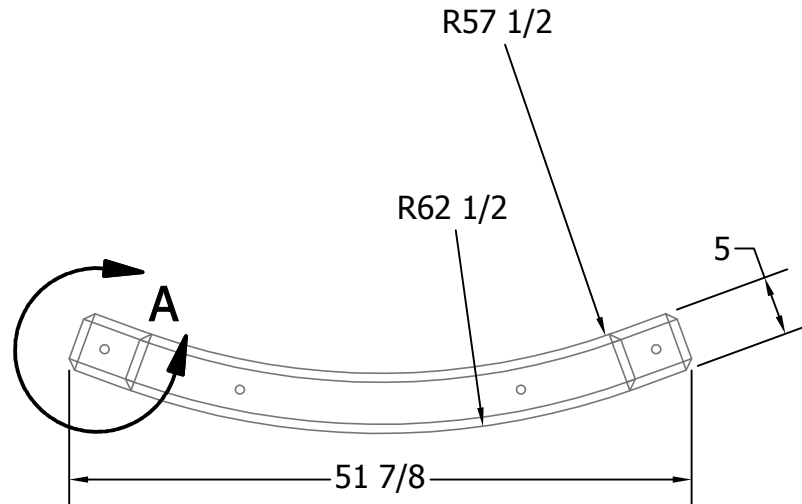

Concrete Products Group, LLC
12901 St. Charles Rock Rd.
Bridgeton, MO 63044
1-800-789-0872
www.frenosystems.com

Project FRENO SYSTEMS	
Title SR5 - Module	
Date 9/20/11	Drawn By: smr
Scale As Noted	Sheet